

Top View

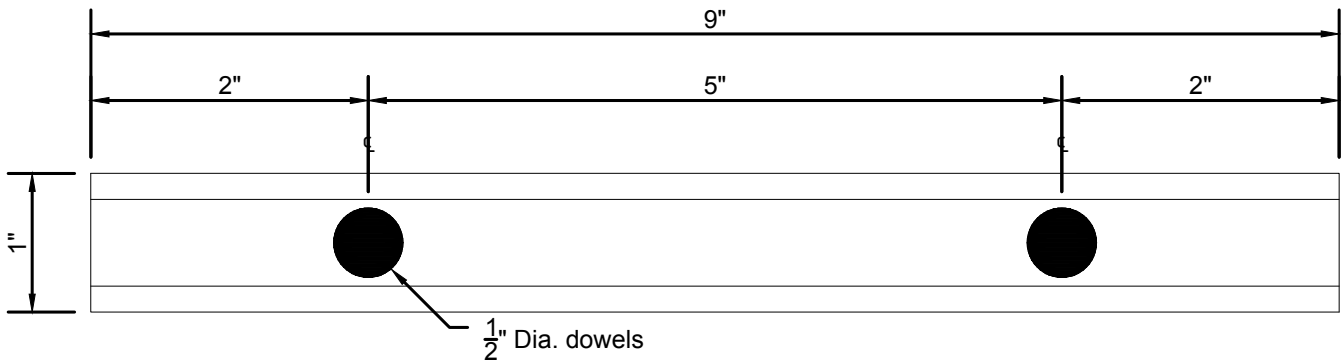

Side View

Notes:
Constructed of white PVC I-bar grating

X _____ Authorization to Fabricate:	_____ Date:
--	----------------

PVC I-Bar Grating

poolequip.com
TM

Project: Standard 9" Perpendicular I-Bar Grating
For Sales Purposes Only

Date: 08/22/17

Drawn by: TJS

Appr'd by:

DWG #:

Scale: N/A

Issue Date:

Item #:

1 of 3

Phone: 800-287-1588
www.poolequip.com

All designs and data included and implied, within the contents of the submitted designs are proprietary. All submitted designs and data are subject to verification from the purchaser/owner. Poolequip will not be held liable based upon inaccurate information and unknown conditions. We reserve the right to modify details without notice where conditions require. No documents shall be modified, copied or reproduced without express written consent of Poolequip. 2008-2017 Poolequip LLC, All Rights Reserved

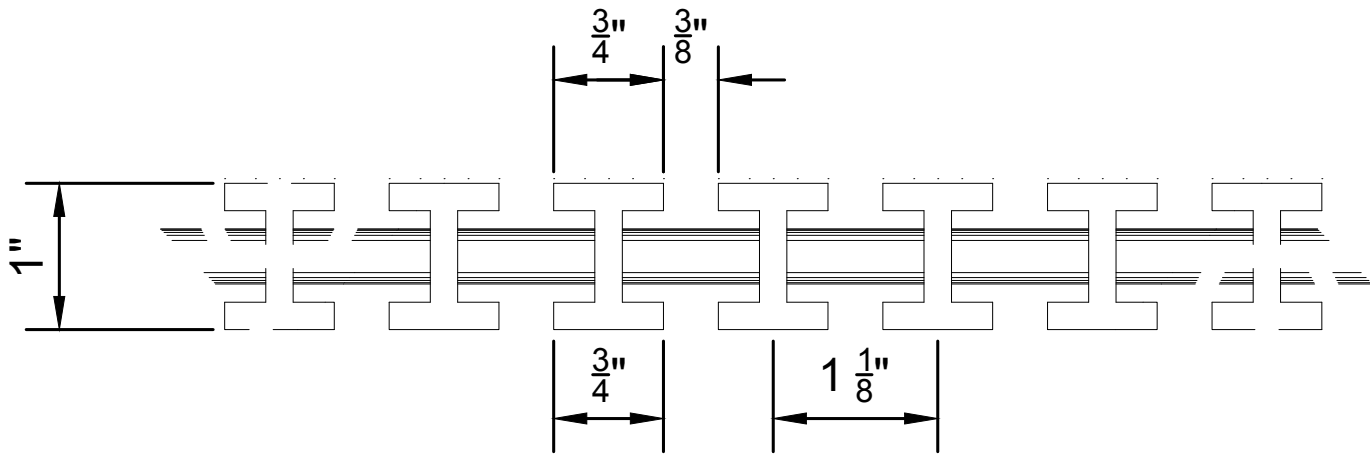

Profile

Technical Data:

Width of I-Bar top	3/4" wide
Gap between bars	3/8" (Max)
Open area/sq. ft.	32%
Grating Height	1"
Grating Upright Thickness	5/16"
Grating Web Thickness	7/32"
Deflection 300 lbs at 18"	3/16"
Maximum Support Span	18" O.C.
Surface Texture	Slip-resistant
Warranty	10 Years
Color	White

Standard crossrods at 8" on center.
Other spacing available upon request.

Design & Product Information:

DuraTech PVC grating is formulated with maximum U.V. inhibitors added to 100% virgin exterior grade impact resistant PVC resin. Integral slip-reistance is embossed into the grating top surface as a standard safety feature. Custom configurations, radius, bends and various designs are available.

Installation:

Grating to be supported and anchored at a maximum of 18" on center and to be supported at all grating section ends. Where two sections butt together provide double grating supports.

DuraTech™ I-Bar

PVC Grating U.V.

poolequip.com
poolequip™

Project: Standard 9" Perpendicular I-Bar Grating
For Sales Purposes Only

Date: 08/22/17

Drawn by: TJS

Appr'd by:

DWG #: Installation/Warranty

Scale: N/A

Issue Date: 05/26/17

Item #:

2 of 3

Phone: 800-287-1588
www.poolequip.com

All designs and data included and implied, within the contents of the submitted designs are proprietary. All submitted designs and data are subject to verification from the purchaser/owner. Poolequip will not be held liable based upon inaccurate information and unknown conditions. We reserve the right to modify details without notice where conditions require. No documents shall be modified, copied or reproduced without express written consent of Poolequip. 2008-2017 Poolequip LLC, All Rights Reserved

Installation Instructions

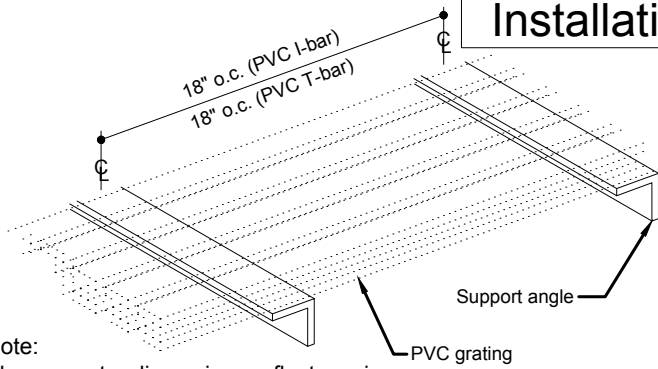

Note:
The on center dimensions reflect maximum distance between supports. Wherever there is a walk in step or ladder, the grating supports shall be spaced at 8" on center throughout the entire step section.

(Diagram A)

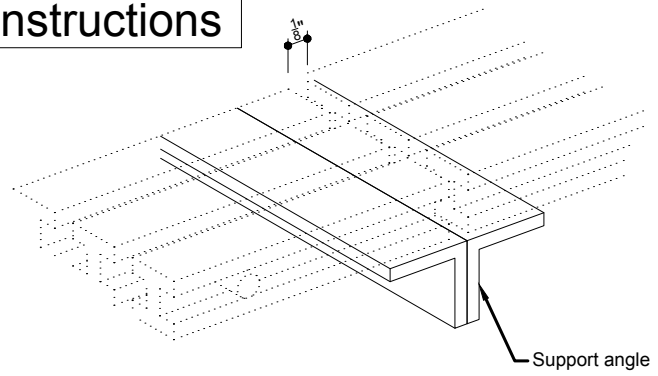

Note:
An $\frac{1}{8}$ " gap is recommended at butt joint.

(Diagram B)

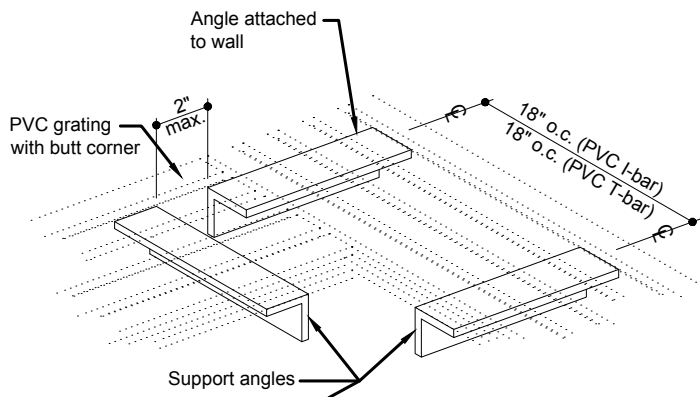

Note:
Make certain that corner grates are fully supported on all sides.

"Standard Butt Corner"

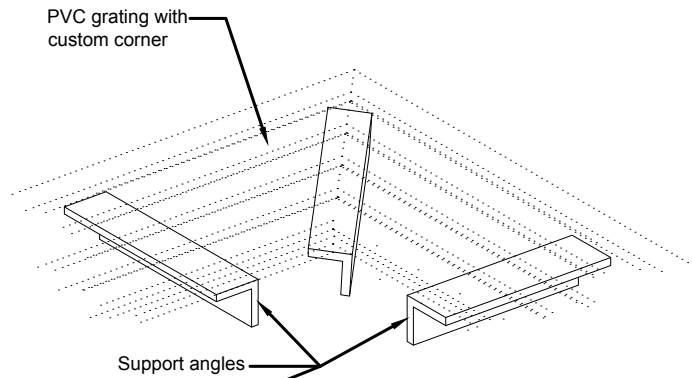

"Pre-mitered Corner"

(Diagram C)

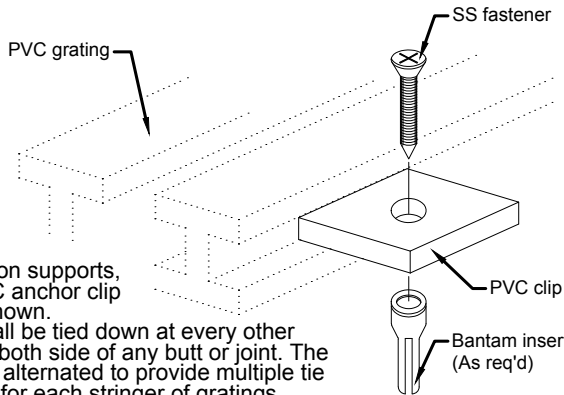

Installation

Locate grating on supports, wedge the PVC anchor clip into place as shown. The grating shall be tied down at every other support and at both side of any butt or joint. The clips should be alternated to provide multiple tie down supports for each stringer of gratings. Shorter grating sections which are less than 7'-0" long shall be tied at every support.

(Diagram D)

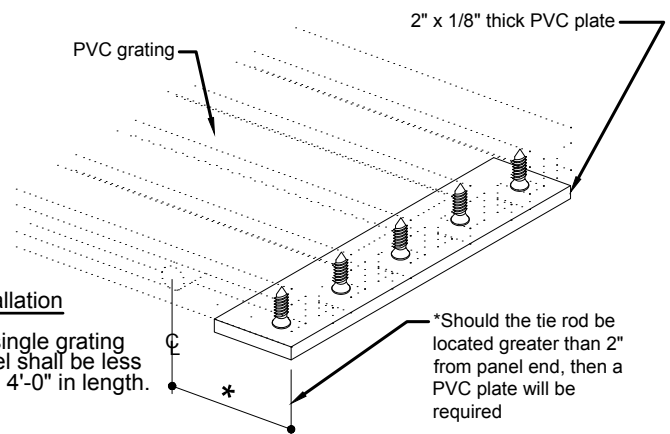

Installation

No single grating panel shall be less than 4'-0" in length.

*Should the tie rod be located greater than 2" from panel end, then a PVC plate will be required

(Diagram E)

poolequip.com
TM

Project: Standard 9" Perpendicular I-Bar Grating
For Sales Purposes Only

Date: 08/22/17

Drawn by: TJS

Appr'd by:

DWG #: GT100A

Scale: N/A

Issue Date: 11/20/06

Item #:

3 of 3

Phone: 800-287-1588
www.poolequip.com

All designs and data included and implied, within the contents of the submitted designs are proprietary. All submitted designs and data are subject to verification from the purchaser/owner. Poolequip will not be held liable based upon inaccurate information and unknown conditions. We reserve the right to modify details without notice where conditions require. No documents shall be modified, copied or reproduced without express written consent of Poolequip. 2008-2017 Poolequip LLC, All Rights Reserved